

DEM Kadetten, Junioren, Masters, Para 2024 - Bielefeld, Germany

03-03-2024

Junioren Male LK1 -80 (Junioren Male-LK1 -80) Contestants: 12

Competition date: 03-03-2024

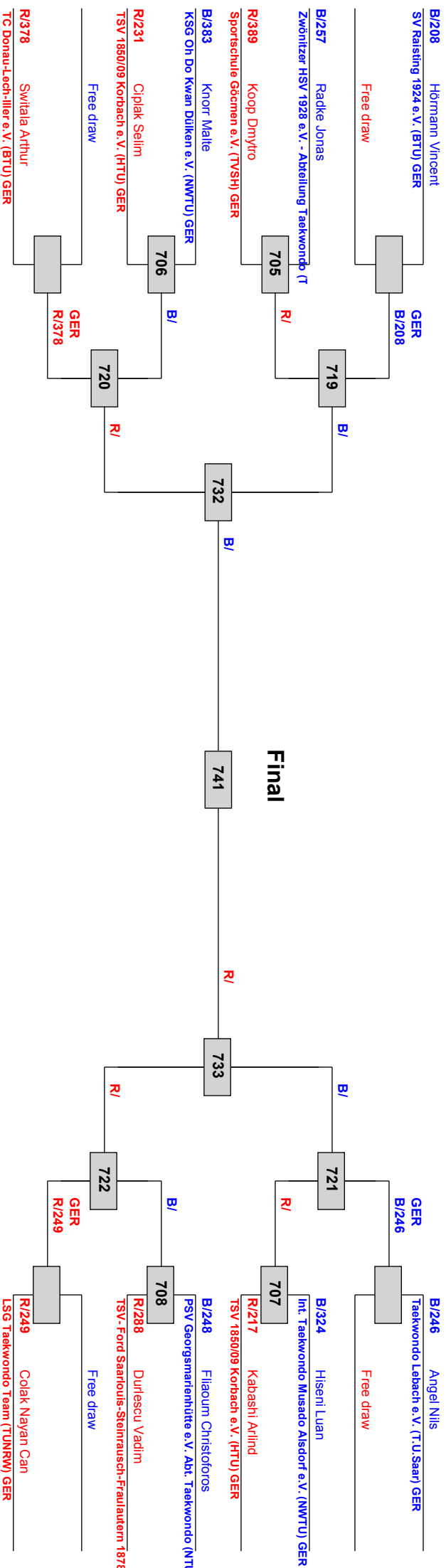

- Result legend:
- (WDR) Withdrawal
 - (DSQ) Disqualified
 - (RSC) Ref. stop contest
 - (SUP) Superiority
 - (PUN) Punishment
 - (GPP) Golden Point
 - (PTG) Points win (gap)
 - (PTF) Points win (normal)
 - (DQB) Unsportsmanlike conduct

Prize winners:



DEM Kadetten, Junioren, Masters, Para 2024 - Bielefeld, Germany

03-03-2024

Junioreren Male LK1 -87 (Junioreren Male-LK1 -87) Contestants: 4

Competition date: 03-03-2024

Final

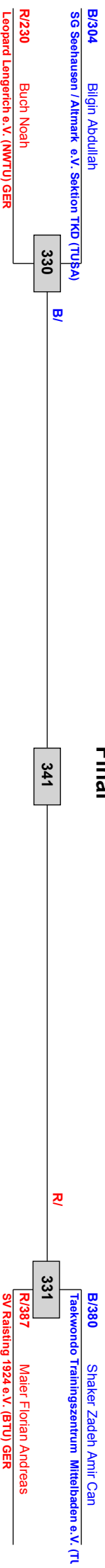

Result legend:
(WDR) Withdrawal
(DSQ) Disqualified
(RSC) Ref. stop contest
(SUP) Superiority
(PUN) Punishment
(GPP) Golden Point
(PTG) Points win (gap)
(PTF) Points win (normal)
(DQB) Unsportsmanlike conduct

Prize winners:

DEM Kadetten, Junioren, Masters, Para 2024 - Bielefeld, Germany

03-03-2024

Junioeren Male LK1 +87 (Junioeren Male-LK1 +87) Contestants: 3

Competition date: 03-03-2024

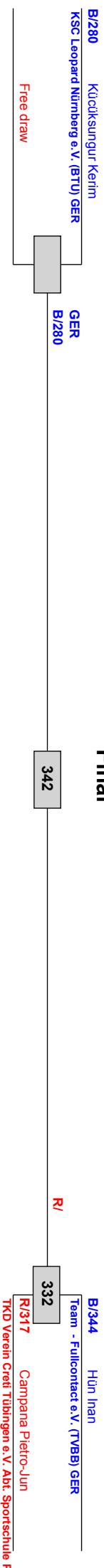

- Result legend:
- (WDR) Withdrawal
 - (DSQ) Disqualified
 - (RSC) Ref. stop contest
 - (SUP) Superiority
 - (PUN) Punishment
 - (GPP) Golden Point
 - (PTG) Points win (gap)
 - (PTF) Points win (normal)
 - (DQB) Unsportsmanlike conduct

Prize winners:

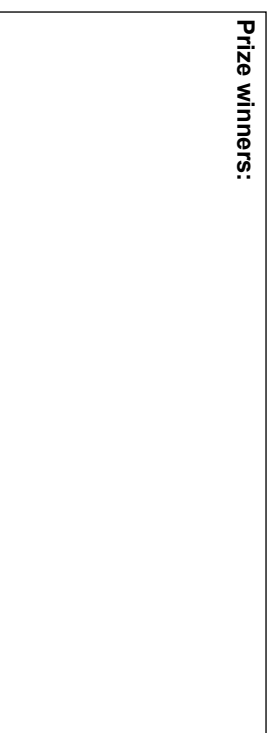

DEM Kadetten, Junioren, Masters, Para 2024 - Bielefeld, Germany

03-03-2024

Juniororen Female LK1 -46 (Juniororen Female-LK1 -46) Contestants: 10
 Competition date: 03-03-2024

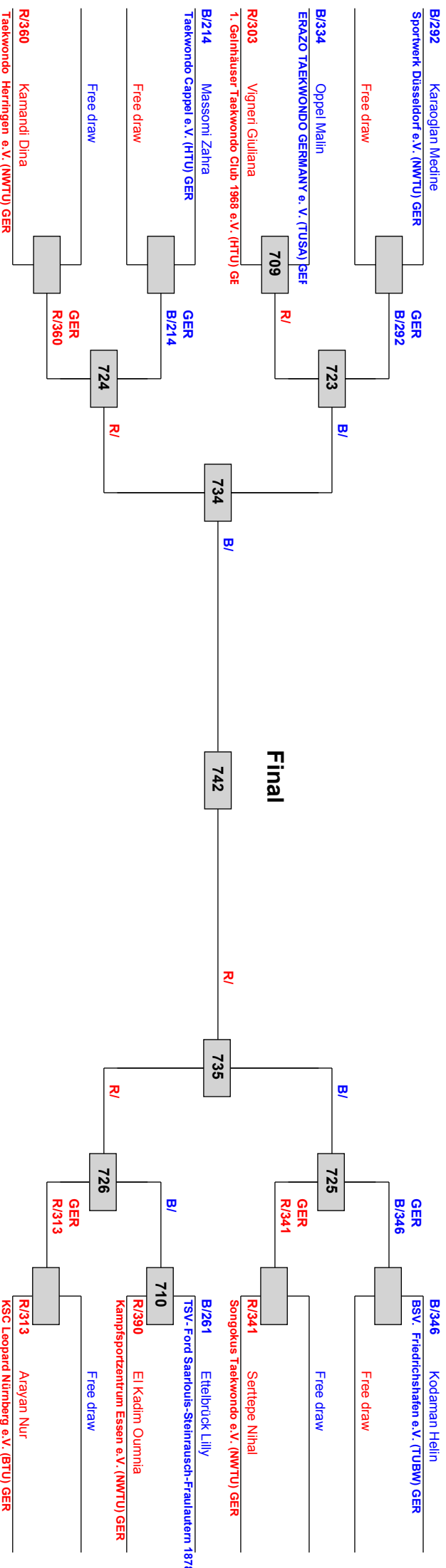

Result legend:
 (WDR) Withdrawal
 (DSQ) Disqualified
 (RSC) Ref. stop contest
 (SUP) Superiority
 (PUN) Punishment
 (GPP) Golden Point
 (PTG) Points win (gap)
 (PTF) Points win (normal)
 (DGB) Unsportsmanlike conduct

Prize winners:

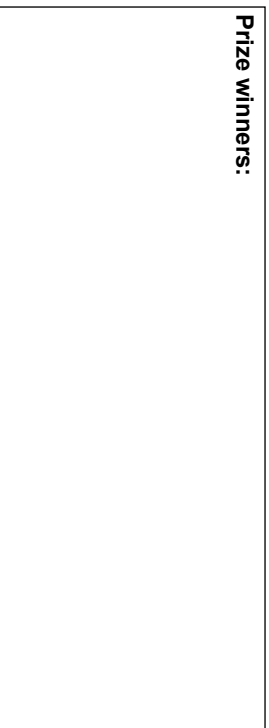

DEM Kadetten, Junioren, Masters, Para 2024 - Bielefeld, Germany

03-03-2024

Junioreren Female LK1 -49 (Junioreren Female-LK1 -49) Contestants: 14

Competition date: 03-03-2024

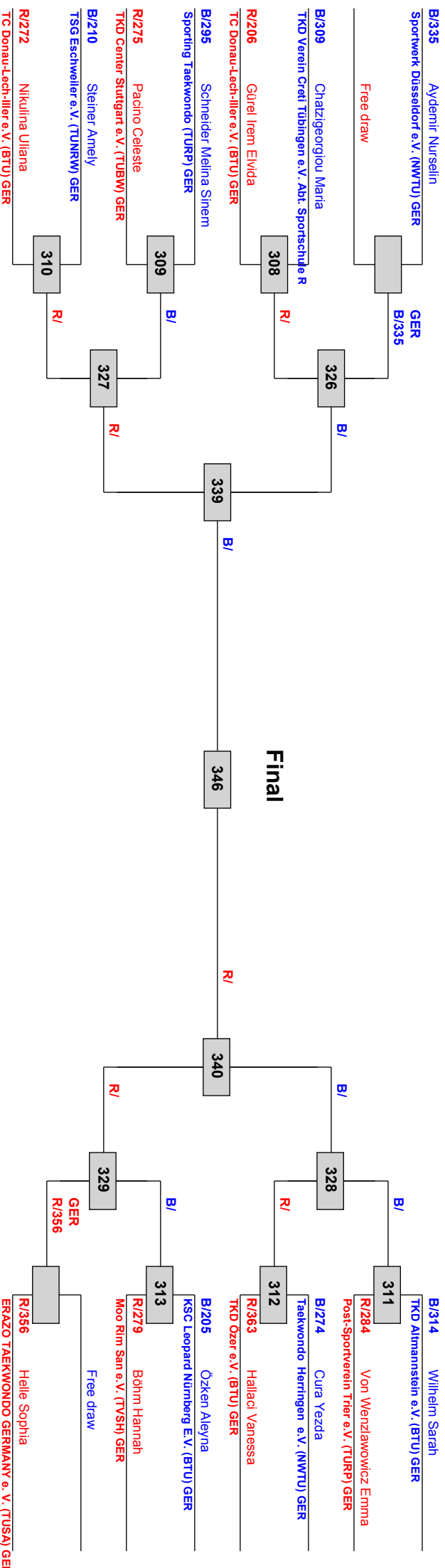

Result legend:
 (WDR) Withdrawal
 (DSQ) Disqualified
 (RSC) Ref. stop contest
 (SUP) Superiority
 (PUN) Punishment
 (GPP) Golden Point
 (PTG) Points win (gap)
 (PTF) Points win (normal)
 (DGB) Unsportsmanlike conduct

Prize winners:

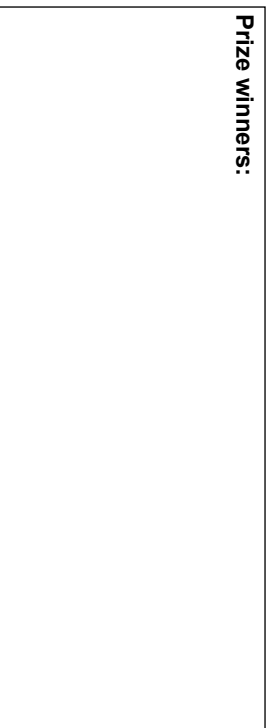

DEM Kadetten, Junioren, Masters, Para 2024 - Bielefeld, Germany

03-03-2024

Juniororen Female LK1 -53 (Juniororen Female-LK1 -53) Contestants: 18

Competition date: 03-03-2024

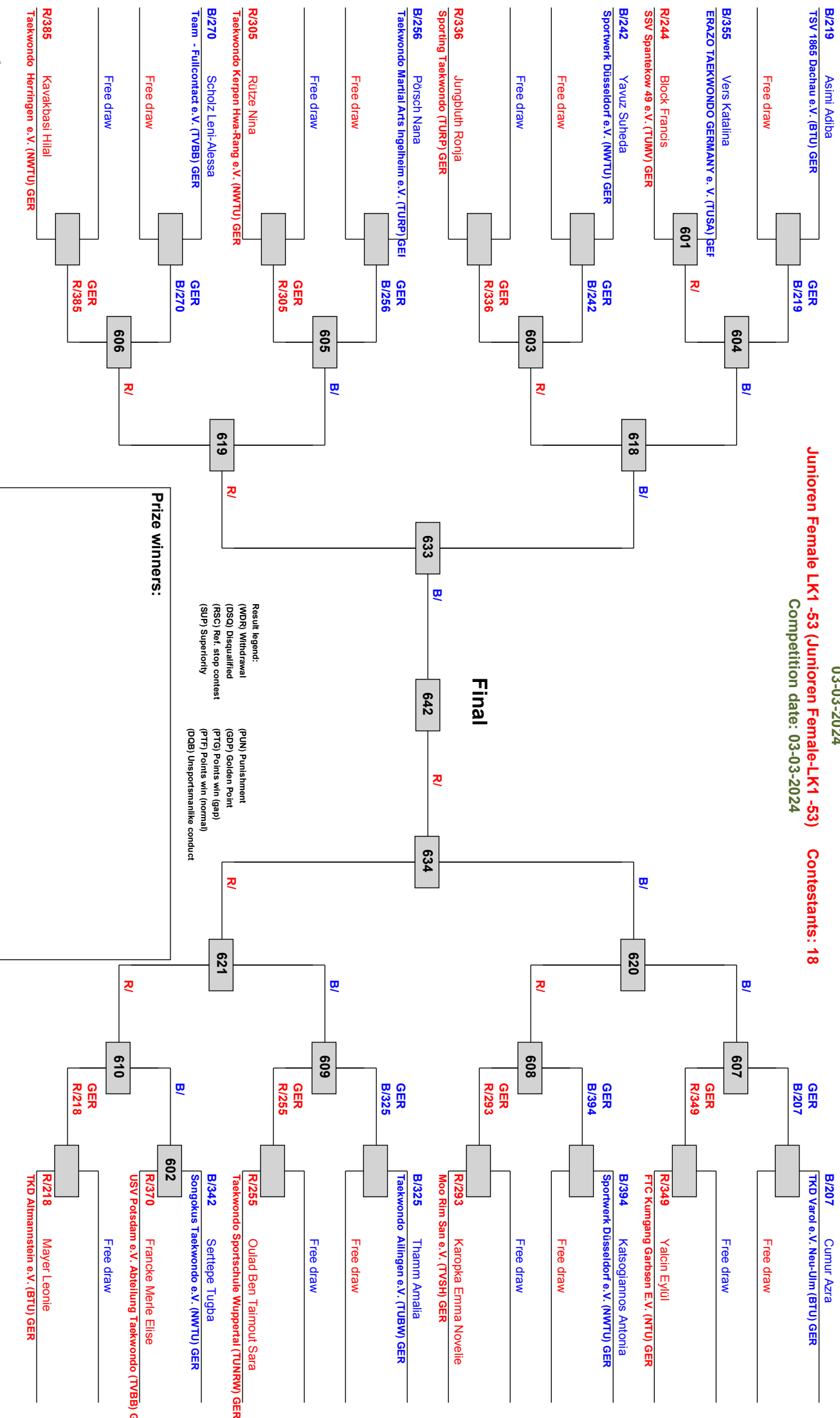

DEM Kadetten, Junioren, Masters, Para 2024 - Bielefeld, Germany

03-03-2024

Juniororen Female LK1 -57 (Juniororen Female-LK1 -57) Contestants: 20

Competition date: 03-03-2024

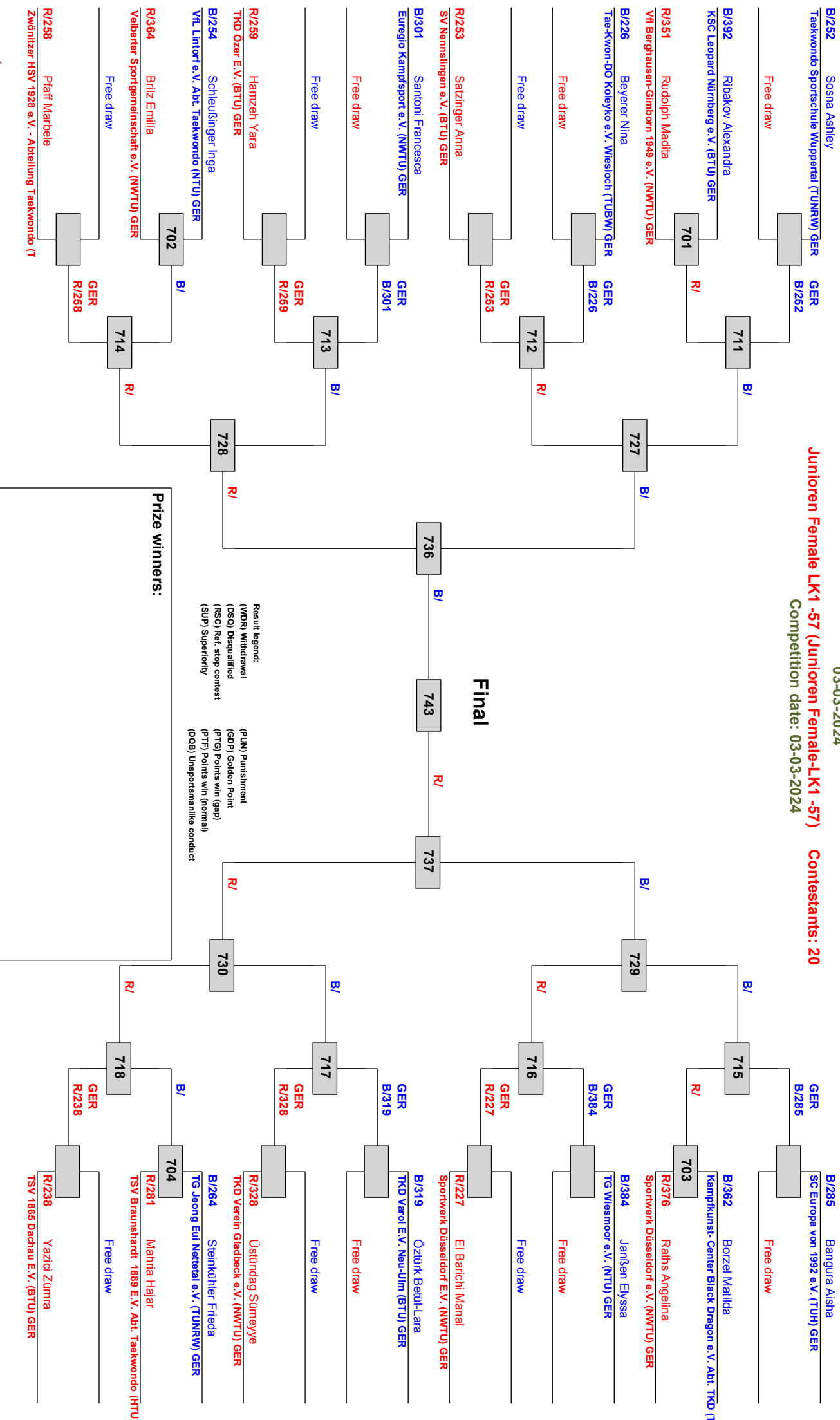

DEM Kadetten, Junioren, Masters, Para 2024 - Bielefeld, Germany

03-03-2024

Junioreren Female LK1 -62 (Junioreren Female-LK1 -62) Contestants: 11

Competition date: 03-03-2024

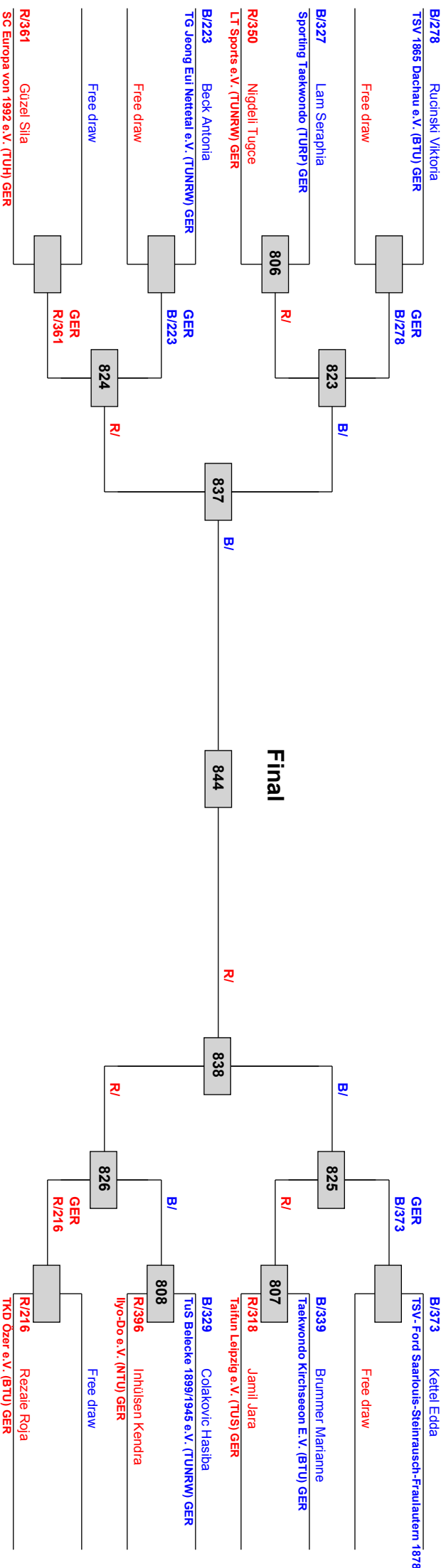

- Result legend:
- (WDR) Withdrawal
 - (DSQ) Disqualified
 - (RSC) Ref. stop contest
 - (SUP) Superiority
 - (PUN) Punishment
 - (GPP) Golden Point
 - (PTG) Points win (gap)
 - (PTF) Points win (normal)
 - (DQB) Unsportsmanlike conduct

Prize winners:

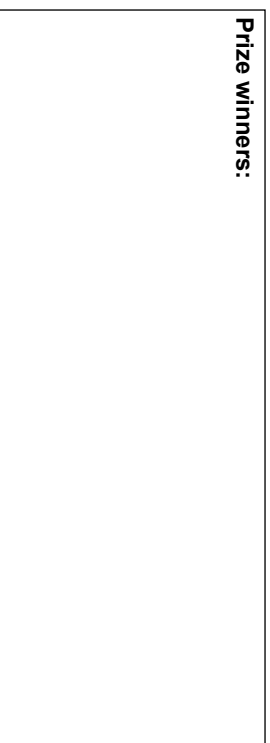

DEM Kadetten, Junioren, Masters, Para 2024 - Bielefeld, Germany

03-03-2024

Junioren Female LK1 -67 (Junioren Female-LK1 -67) Contestants: 7

Competition date: 03-03-2024

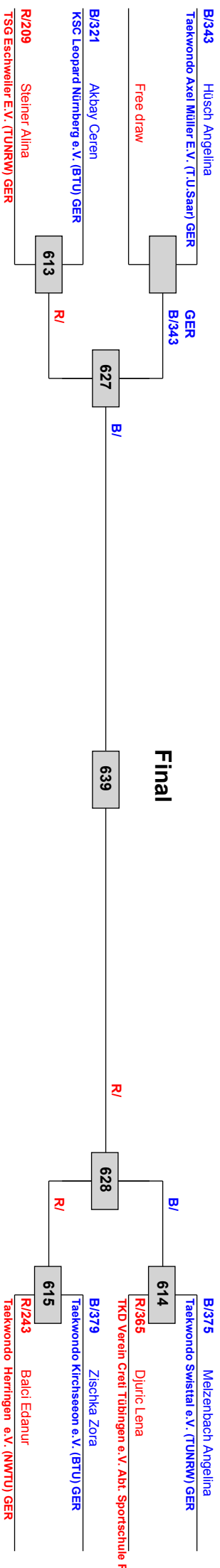

- Result legend:
- (WDR) Withdrawal
 - (DSQ) Disqualified
 - (RSC) Ref. stop contest
 - (SUP) Superiority
 - (PUN) Punishment
 - (GPP) Golden Point
 - (PTG) Points win (gap)
 - (PTF) Points win (normal)
 - (DQB) Unsportsmanlike conduct

Prize winners:



DEM Kadetten, Junioren, Masters, Para 2024 - Bielefeld, Germany

03-03-2024

Junioren Female LK1 -73 (Junioren Female-LK1 -73) Contestants: 6

Competition date: 03-03-2024

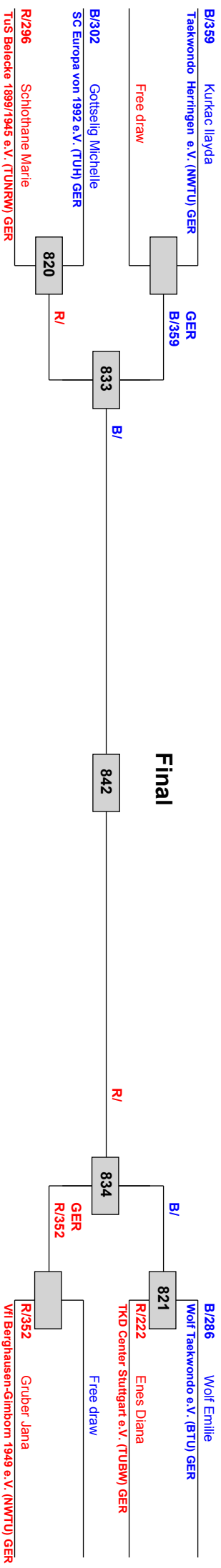

Result legend:

- (WDR) Withdrawal
- (DSQ) Disqualified
- (RSC) Ref. stop contest
- (SUP) Superiority
- (PUN) Punishment
- (GPP) Golden Point
- (PTG) Points win (gap)
- (PTF) Points win (normal)
- (DGB) Unsportsmanlike conduct

Prize winners:



DEM Kadetten, Junioren, Masters, Para 2024 - Bielefeld, Germany

03-03-2024

Junioren Female LK1 +73 (Junioren Female-LK1 +73) Contestants: 2

Competition date: 03-03-2024

B/204 Husovic Esmeralda

TSV 1865 Dachau e.V. (BTU) GER

738

R/381 Koushan Diviana Lara

Sportwerk Düsseldorf e.V. (NWTTU) GER

Result legend:
(WDR) Withdrawal
(DSQ) Disqualified
(RSC) Ref. stop contest
(SUP) Superiority
(PUN) Punishment
(GPP) Golden Point
(PTG) Points win (gap)
(PTF) Points win (normal)
(DQB) Unsportsmanlike conduct

Prize winners:

